

Kurzschenkelige Fittings

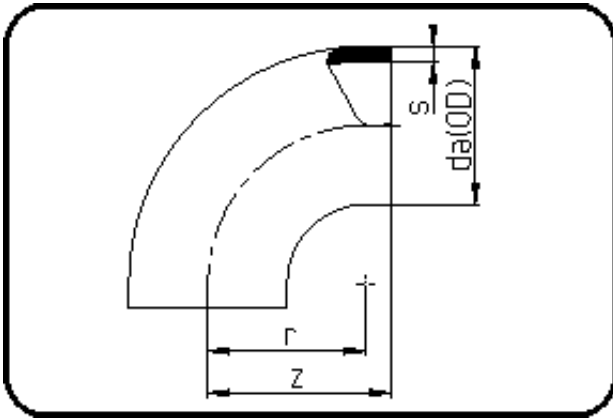

Code: 001

- Bogen 90°
- kurze Schenkel
- formgespritzt
- **Stumpfschweissung**
- **PE 100-RC schwarz**

Dimension	Code	Detail	Gewicht
280	70.001.0280.17	280X16,6 SDR17 ISO S-8	7.14

	Einheit	Nominale	Tol+	Tol-
da(OD)	mm	280	2.60	0.00
r	mm	265	0.00	0.00
s	mm	16,6	1.80	0.00
z	mm	290	6.00	6.00