

Kurzschenkelige Fittings

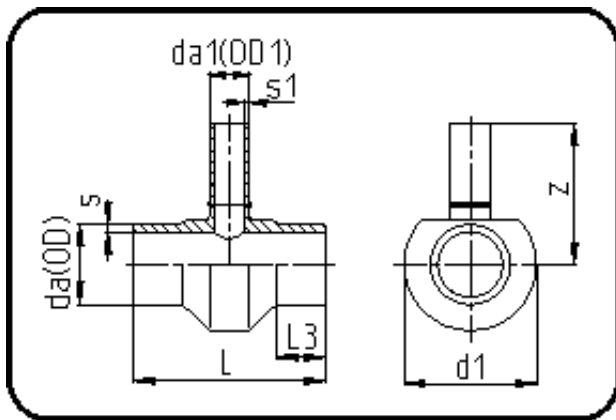

Code: 307

- T-Stück reduziert
- kurze Schenkel
- mechanisch gefertigt
- **Stumpfschweissung**
- **PE 100-RC schwarz**

Dimension	Code	Detail	Gewicht
450/250	70.307.4525.09	450/250 SDR9 ISO S-4	50.00

	Einheit	Nominale	Tol+	Tol-
da(OD)	mm	450	4.10	0.00
L	mm	450	3.00	3.00
L3	mm	75	1.00	1.00
s	mm	50,3	5.20	0.00
d1	mm	560	1.00	1.00
s1	mm	27,9	2.90	0.00
da(OD1)	mm	250	2.30	0.00
z	mm	400	7.50	7.50