

PE 100-RC Poly-Flo

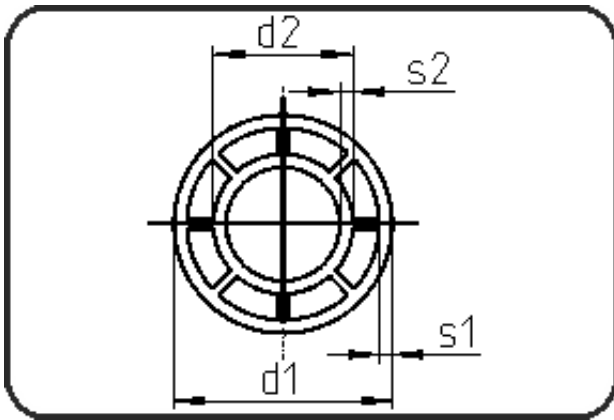

Code: 785.1

- Poly-Flo Rohr 5m
- extrudiert
- **Simultan + Kaskadenschweissung**
- PE 100-RC schwarz

Dimension	Code	Detail	Gewicht
90/63	70.785.9063.71	90/63 SDR17/11	2.65

	Einheit	Nominale	Tol+	Tol-
d1	mm	90	0.90	0.00
s2	mm	5,8	0.70	0.00
d2	mm	63	0.60	0.00
s1	mm	5,4	0.70	0.00