

## MULTI Fittings

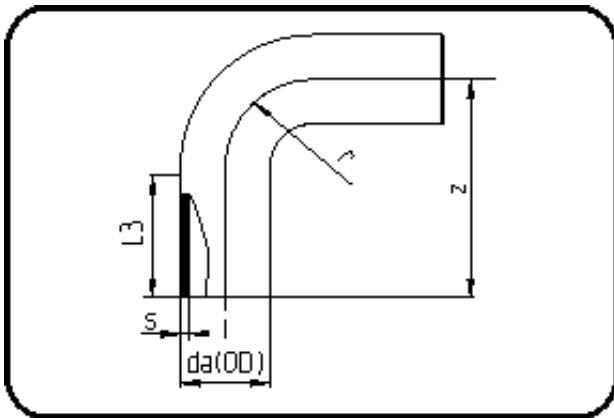

Code: 068

- **MULTI-Bogen 90°**
- lange Schenkel
- elektrisch leitfähig
- formgespritzt
- **Stumpf + E-Muffenschweissung**
- **PE 100-el schwarz**

Dimension	Code	Detail	Gewicht
160	28.068.0160.11	160X14,6 SDR11 ISO S-5	3.57

	Einheit	Nominale	Tol+	Tol-
da(OD)	mm	160	1.50	0.00
L3	mm	100,5	3.00	3.00
r	mm	160	0.00	0.00
s	mm	14,6	1.60	0.00
z	mm	261,5	6.00	6.00