

## Fittings

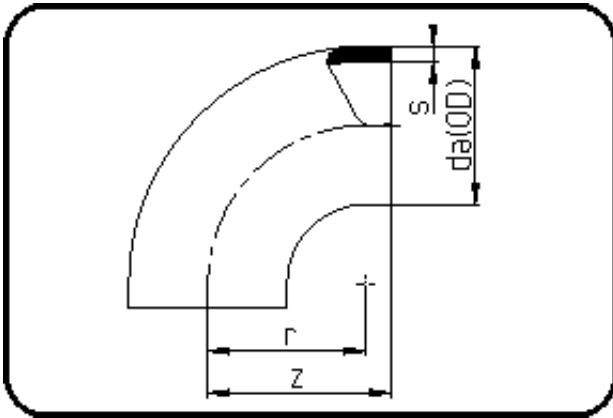

Code: 001

- Bogen 90°
- kurze Schenkel
- formgespritzt
- **Stumpf+IR-Schweissung**
- PVDF natur

Dimension	Code	Detail	Gewicht
250	30.001.0250.33	250X7,7 SDR33 ISO S-16	5.46

	Einheit	Nominale	Tol+	Tol-
da(OD)	mm	250	1.60	0.00
r	mm	250	0.00	0.00
s	mm	7,7	1.00	0.00
z	mm	287	3.00	3.00